









FIXING INSTALLATION FOR RAISED SEAT

THIS IS A BOTTOM FIXING SEAT AND IT IS ONLY POSSIBLE TO FIT THIS PRODUCT BY ACCESSING THE FIXINGS FROM BELOW THE SEAT

COMPONENT LIST

	A. Hinge Plate Washer x 2		E. Fixing Key x 1
	B. Long Bolt x 2		F. Seat Retaining Buffer screw x 2
	C. Rubber Coated Washer x 2		G. Seat Position Retaining Buffer x 2
	D. Fixing Nut x 2		H. Seat Buffer x 2

Step 1

1. Remove both of components F (Seat Retaining Buffer Screw) pre fitted in the seat buffer holes and keep safe as you will need them later in the fitting process.

Step 2

1. Fit component A (Hinge Plate Washer) to underside of Hinge plate already fitted on the seat
2. Place seat on pan and position to fit correctly over the pan opening.
3. Insert component B (Long Bolt) through the **underside** of the pan engaging into one of the five fixing holes and thread all the way into threaded the fixing holes.
4. Fit component C (Rubber Washer) over threaded bolt **FULL RUBBER SIDE UP** (SEE (see Fig 1)
5. Screw on component D (Nut) and tighten to fix seat into position using component E (Fixing Key)

Step 3

1. Lift the seat into the vertical position and insert the component G (Seat Position Retraining Buffer) ensuring the long retainers fit into the inside edge of the pan.
2. Once fitted secure using component F (being the screws removed in step 1) and fasten tightly. Take care not to drop screws down the pan at this point. (Do not overtighten as these can be re tightened over time if necessary.

CLEANING INSTRUCTIONS

Only use clean soapy water. The seat can be steam cleaned.

Do not use abrasive cleaning products or products containing chlorine or acids, as these may cause yellowing or peeling of the material. Use **ONLY** a mild detergent/non-abrasive household cleaner or neutral soap or natural household cleaning products which are best for effective, problem-free cleaning. Do not use bleach or any products containing bleach on the seat. Do not mix cleaning products as this can cause a reaction. After cleaning, ensure the chrome hinge is dried. Leave the seat and lid up whenever strong cleaning products (such as bleach) are left in the pan bowl to prevent damage to the seat from the vapours.

TOOLS REQUIRED

Tools you will need not supplied.
**Hand Held Philips Head
Screwdriver**

Tools Required 

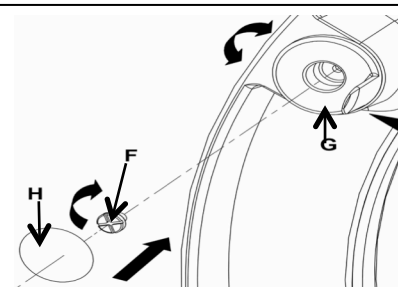
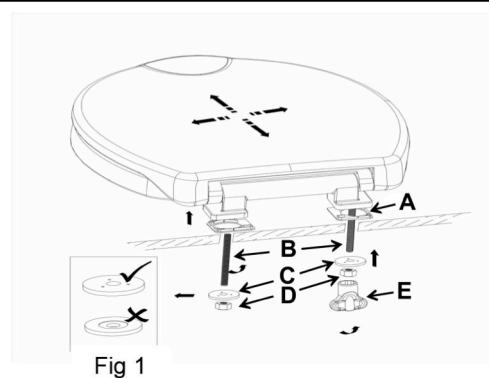

CARE INSTRUCTIONS

- **Seat & hinges to be adjusted before tightening**
- **This seat is equipped with a slow close mechanism - do not force down**
- **Keep Fixing Key Safe and Check seat tightening from time to time to ensure stability**